

# A22

## 0.5W Series



### Features

- ◆ Moisture Sensitivity Level: 3
- ◆ Main Parameters: Luminous Flux, Forward Voltage , Chromaticity and Color Rendering Index
- ◆ RoHS compliant
- ◆ Typical viewing angle: 115°

### Applications

- ◆ High Wattage Replacement Bulb
- ◆ Down Light
- ◆ Recessed Can Light
- ◆ Low/High Bay Light

### Materials

Items	Description
Encapsulating Resin	Silicone resin
Electrodes	Ag plating copper alloy
Die attach	Silver paste
Chip	InGaN

## Product Nomenclature

The product name is designated as below:

### EHP-A22/ ABCDE –FGH/IJKL/MNO/PQ

Designation:

AB = color <sup>[1]</sup>

CDE = internal coding

FGH = power consumption <sup>[2]</sup>

IJKL = color range or CCT Range

MNO = luminous flux bin

PQ = packaging type <sup>[3]</sup>

#### Notes

1. Table of color offerings:

Symbol	Color	CCT range	Color Rendering Index
GT	Cool-White	4745~7050K	>65
KT	Cool-White	4745~7050K	>80
LM	Warm-White	2580~3710K	>70
	Neutral-White	3710K-4745K	
KM	Warm White	2580~3710K	>80
	Neutral-White	3710K-4745K	

2. Table of power consumption :

Symbol	Description
PU5	0.5W

3. Table of packaging types:

Symbol	Description
TR	Tapping Reel

## Absolute Maximum Ratings

Parameter	Symbol	Ratings	Unit
Max. DC Forward Current (mA)	$I_F$	150	mA
Max. Peak Pulse Current (mA)	$I_{Pulse}$	180 <sub>[1]</sub>	mA
Thermal Resistance	$R_{th}$	15	°C/W
Max. Junction Temperature	$T_J$	125	°C
Operating Temperature	$T_{Opr}$	-40 ~ +85	°C
Storage Temperature	$T_{Stg}$	-40 ~ +100	°C
Max. Soldering Temperature	$T_{Sol}$	260	°C

**Notes:**

1.  $t_p$  100ms, Duty cycle = 25%

**PN of the A22 series: Warm White LEDs**

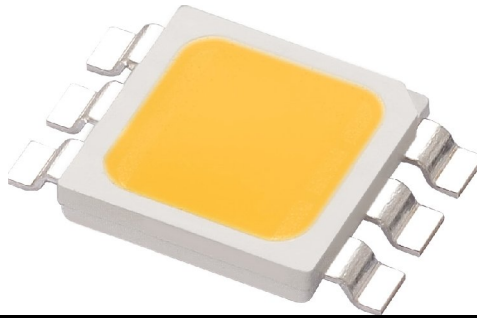

Order Code of A22	Min. Luminous Flux (lm)	Typ. Luminous Flux (lm)	CCT (K) Wavelength (nm)	Forward Voltage (V)	Forward Current (mA)	CRI (Min.)
EHP-A22/KM31H-PU5/35K/J3/TR	33	42	35K-1,35K-2 35K-3,35K-4	2.95~3.85	150	80
EHP-A22/KM31H-PU5/30K/J3/TR	33	40	30K-1,30K-2 30K-3,30K-4	2.95~3.85	150	80
EHP-A22/KM31H-PU5/27K/J2/TR	27	37	27K-1,27K-2 27K-3,27K-4	2.95~3.85	150	80
EHP-A22/KM01H-PU5/35K/J5/TR	45	48	35K-1,35K-2 35K-3,35K-4	2.95~3.85	150	80
EHP-A22/KM01H-PU5/30K/J5/TR	45	48	30K-1,30K-2 30K-3,30K-4	2.95~3.85	150	80
EHP-A22/KM01H-PU5/27K/J4/TR	39	43	27K-1,27K-2 27K-3,27K-4	2.95~3.85	150	80

**Notes:**

1. Luminous flux measurement tolerance:  $\pm 10\%$ .
2. The data of luminous flux measured at thermal pad=25°C
3. Typical luminous flux or light output performance is operated within the condition guided by this datasheet
4. The CRI value is based on the Everlight testing instrument.
5. CRI measurement tolerance:  $\pm 2$

**PN of the A22 series: Neutral White LEDs**

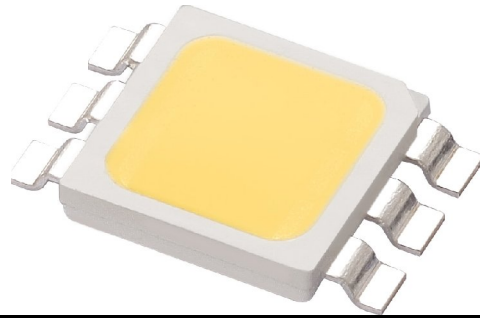

Order Code of A22	Min. Luminous Flux (lm)	Typ. Luminous Flux (lm)	CCT (K) Wavelength (nm)	Forward Voltage (V)	Forward Current (mA)	CRI (Min.)
EHP-A22/KM31H-PU5/45K/J3/TR	33	44	45K-1,45K-2 45K-3,45K-4	2.95~3.85	150	80
EHP-A22/KM31H-PU5/40K/J3/TR	33	43	40K-1,40K-2 40K-3,40K-4	2.95~3.85	150	80
EHP-A22/KM01H-PU5/45K/J5/TR	45	49	45K-1,45K-2 45K-3,45K-4	2.95~3.85	150	80
EHP-A22/KM01H-PU5/40K/J5/TR	45	49	40K-1,40K-2 40K-3,40K-4	2.95~3.85	150	80

**Notes:**

6. Luminous flux measurement tolerance:  $\pm 10\%$ .
7. The data of luminous flux measured at thermal pad=25°C
8. Typical luminous flux or light output performance is operated within the condition guided by this datasheet
9. The CRI value is based on the Everlight testing instrument.
10. CRI measurement tolerance:  $\pm 2$

**PN of the A22 series: Cool White LEDs**

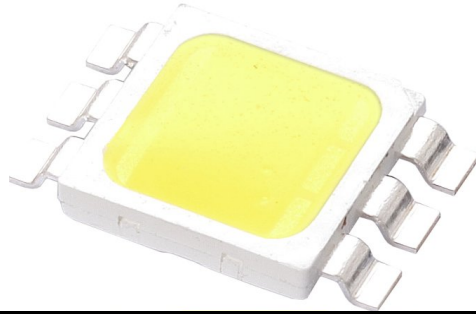

Order Code of A22	Min. Luminous Flux (lm)	Typ. Luminous Flux (lm)	CCT (K) Wavelength (nm)	Forward Voltage (V)	Forward Current (mA)	CRI (Min.)
EHP-A22/GT31H-PU5/65K/J4/TR	39	48	65K-1, 65K-2 65K-3, 65K-4	2.95~3.85	150	65
EHP-A22/GT31H-PU5/57K/J4/TR	39	50	57K-1, 57K-2 57K-3, 57K-4	2.95~3.85	150	65
EHP-A22/ GT 31H-PU5/50K/J4/TR	39	46	50K-1, 50K-2 50K-3, 50K-4	2.95~3.85	150	65
EHP-A22/GT01H-PU5/57K/K1/TR	52	57	57K-1, 57K-2 57K-3, 57K-4	2.95~3.85	150	65
EHP-A22/ GT01H-PU5/50K/K1/TR	52	55	50K-1, 50K-2 50K-3, 50K-4	2.95~3.85	150	65

**Notes:**

11. Luminous flux measurement tolerance:  $\pm 10\%$ .
12. The data of luminous flux measured at thermal pad=25°C
13. Typical luminous flux or light output performance is operated within the condition guided by this datasheet
14. The CRI value is based on the Everlight testing instrument.
15. CRI measurement tolerance:  $\pm 2$

## Product Binning

### Luminous Flux Bins

Group	Bin	Min	Typ.	Max
E	1	1.5	----	3
	2	3	----	4
	3	4	----	5
	4	5	----	6
	5	6	----	8
F	1	8	----	10
	2	10	----	13
	3	13	----	17
	4	17	----	20
	5	20	----	23
J	1	23	----	27
	2	27	----	33
	3	33	----	39
	4	39	----	45
	5	45	----	52
K	1	52	----	60
	2	60	----	70
	31	70	----	75
	32	75	----	80
	33	80	----	85
	41	85	----	90
	42	90	----	95
	43	95	----	100
	51	100	----	110
	52	110	----	120
	53	120	----	130

Group	Bin	Min	Typ.	Max
N	11	130	----	140
	12	140	----	150
	13	150	----	160
	21	160	----	180
	22	180	----	200
	31	200	----	225
	32	225	----	250
	41	250	----	275
	42	275	----	300
	51	300	----	350
R	52	350	----	400
	1	400	----	500
	2	500	----	600
	3	600	----	750
	4	750	----	1000
	5	1000	----	1300

### White Bin Structure

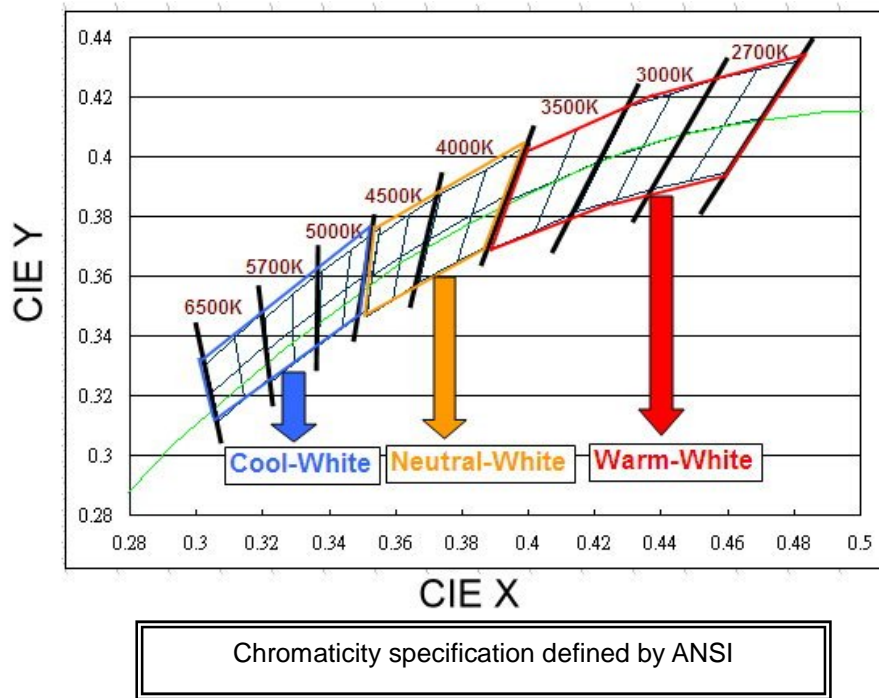

**Notes:**

1. The CCT range of Cool-White varies from 4745K to 7050K.
2. The CCT range of Neutral-White varies from 3710K to 4745K.
3. The CCT range of Warm-White varies from 2580K to 3710K
4. Color coordinates measurement allowance :  $\pm 0.01$
5. Color bins are defined at  $I_f=150\text{mA}$  operation.

### Warm-White Bin Structure

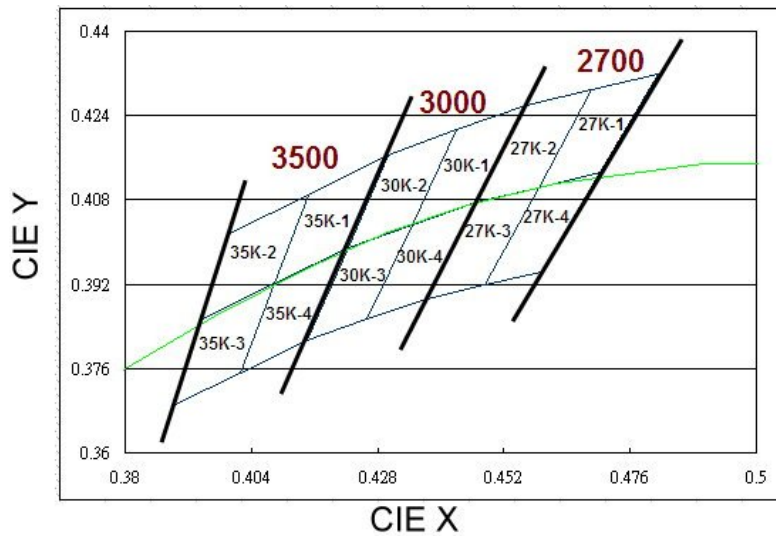



**Warm-White Bin Coordinates**

**2700K**

Bin	CIE X	CIE Y
27K-1	0.469	0.429
	0.459	0.410
	0.470	0.413
	0.481	0.432
Reference Range: 2580~2700K		

Bin	CIE X	CIE Y
27K-2	0.456	0.426
	0.447	0.408
	0.459	0.410
	0.469	0.429
Reference Range: 2700~2870K		

Bin	CIE X	CIE Y
27K-4	0.459	0.410
	0.448	0.392
	0.459	0.394
	0.470	0.413
Reference Range: 2580~2700K		

Bin	CIE X	CIE Y
27K-3	0.447	0.408
	0.437	0.389
	0.448	0.392
	0.459	0.410
Reference Range: 2700~2870K		

**3000K**

Bin	CIE X	CIE Y
30K-1	0.443	0.421
	0.435	0.403
	0.447	0.408
	0.456	0.426
Reference Range: 2870~3000K		

Bin	CIE X	CIE Y
30K-2	0.430	0.417
	0.422	0.399
	0.435	0.403
	0.443	0.421
Reference Range: 3000~3220K		

Bin	CIE X	CIE Y
30K-4	0.435	0.403
	0.426	0.385
	0.437	0.389
	0.447	0.408
Reference Range: 2870~3000K		

Bin	CIE X	CIE Y
30K-3	0.422	0.399
	0.415	0.381
	0.426	0.385
	0.435	0.403
Reference Range: 3000~3220K		

**3500K**

Bin	CIE X	CIE Y
35K-1	0.415	0.409
	0.408	0.392
	0.422	0.399
	0.430	0.417
Reference Range: 3220~3500K		

Bin	CIE X	CIE Y
35K-2	0.400	0.402
	0.394	0.385
	0.408	0.392
	0.415	0.409
Reference Range: 3500~3710K		

Bin	CIE X	CIE Y
35K-4	0.408	0.392
	0.402	0.375
	0.415	0.381
	0.422	0.399
Reference Range: 3220~3500K		

Bin	CIE X	CIE Y
35K-3	0.394	0.385
	0.389	0.369
	0.402	0.375
	0.408	0.392
Reference Range: 3500~3710K		

Neutral-White Bin Structure

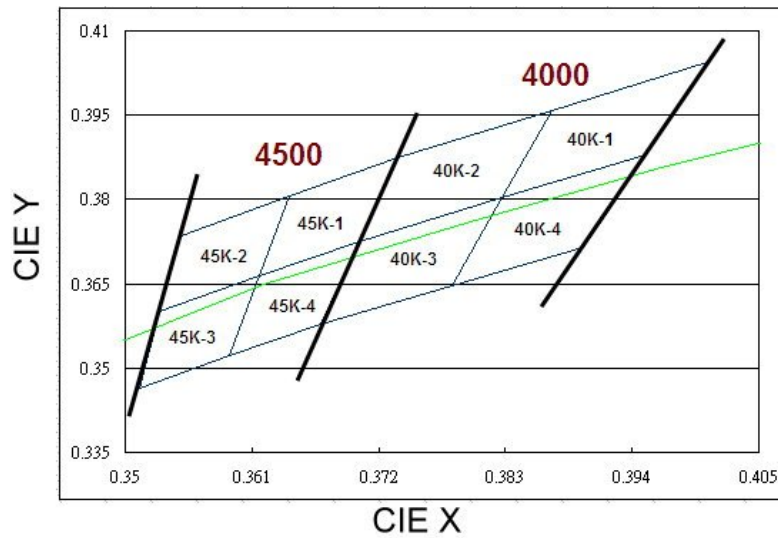

Neutral-White Bin Coordinates

4000K

Bin	CIE X	CIE Y
40K-1	0.387	0.396
	0.383	0.380
	0.395	0.388
	0.401	0.404
Reference Range: 3710~4000K		

Bin	CIE X	CIE Y
40K-2	0.374	0.387
	0.370	0.373
	0.383	0.380
	0.387	0.396
Reference Range: 4000~4260K		

Bin	CIE X	CIE Y
40K-4	0.383	0.380
	0.378	0.365
	0.390	0.372
	0.395	0.388
Reference Range: 3710~4000K		

Bin	CIE X	CIE Y
40K-3	0.370	0.373
	0.367	0.358
	0.378	0.365
	0.383	0.380
Reference Range: 4000~4260K		

4500K

Bin	CIE X	CIE Y
45K-1	0.364	0.381
	0.362	0.366
	0.370	0.373
	0.374	0.387
Reference Range: 4260~4500K		

Bin	CIE X	CIE Y
45K-2	0.355	0.374
	0.353	0.360
	0.362	0.366
	0.364	0.381
Reference Range: 4500~4745K		

Bin	CIE X	CIE Y
45K-4	0.362	0.366
	0.359	0.352
	0.367	0.358
	0.370	0.373
Reference Range: 4260~4500K		

Bin	CIE X	CIE Y
45K-3	0.353	0.360
	0.351	0.347
	0.359	0.352
	0.362	0.366
Reference Range: 4500~4745K		

**Cool-White Bin Structure**

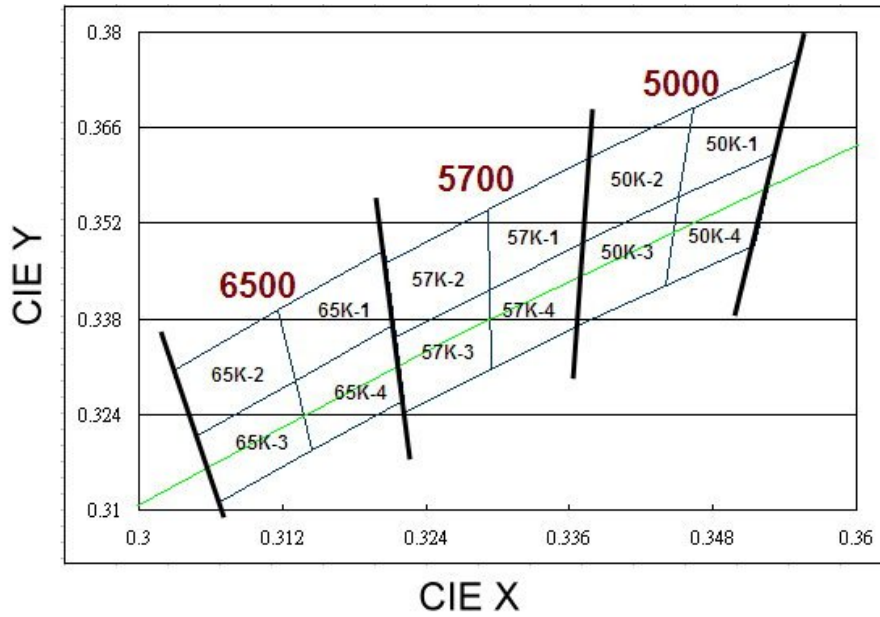

**5000K**

Bin	CIE X	CIE Y
50K-1	0.346	0.369
	0.345	0.356
	0.353	0.362
	0.355	0.376
Reference Range: 4745~5000K		

Bin	CIE X	CIE Y
50K-2	0.338	0.362
	0.337	0.349
	0.345	0.356
	0.346	0.369
Reference Range: 5000~5310K		

Bin	CIE X	CIE Y
50K-4	0.345	0.356
	0.344	0.343
	0.352	0.349
	0.353	0.362
Reference Range: 4745~5000K		

Bin	CIE X	CIE Y
50K-3	0.337	0.349
	0.337	0.337
	0.344	0.343
	0.345	0.356
Reference Range: 5000~5310K		

**5700K**

Bin	CIE X	CIE Y
57K-1	0.329	0.354
	0.329	0.342
	0.337	0.349
	0.338	0.362
Reference Range: 5310~5700K		

Bin	CIE X	CIE Y
57K-2	0.321	0.346
	0.322	0.335
	0.329	0.342
	0.329	0.354
Reference Range: 5700~6020K		

Bin	CIE X	CIE Y
57K-4	0.329	0.342
	0.329	0.331
	0.337	0.337
	0.337	0.349
Reference Range: 5310~5700K		

Bin	CIE X	CIE Y
57K-3	0.322	0.335
	0.322	0.324
	0.329	0.331
	0.329	0.342
Reference Range: 5700~6020K		

**Cool-White Bin Coordinates**

**6500K**

Bin	CIE X	CIE Y
65K-1	0.312	0.339
	0.313	0.329
	0.321	0.337
	0.321	0.348
Reference Range: 6020~6500K		

Bin	CIE X	CIE Y
65K-2	0.303	0.330
	0.305	0.321
	0.313	0.329
	0.312	0.339
Reference Range: 6500~7050K		

Bin	CIE X	CIE Y
65K-4	0.313	0.329
	0.315	0.319
	0.322	0.326
	0.321	0.337
Reference Range: 6020~6500K		

Bin	CIE X	CIE Y
65K-3	0.305	0.321
	0.307	0.311
	0.315	0.319
	0.313	0.329
Reference Range: 6500~7050K		

**Notes:**

1. Color coordinates measurement allowance :  $\pm 0.01$ .

### Forward Voltage Bins

Bin	Minimum Forward Voltage (V)	Maximum Forward Voltage (V)
V1	2.95	3.25
V2	3.25	3.55
V3	3.55	3.85

**Notes:**

1. Forward voltage measurement tolerance:  $\pm 0.1V$ .
2. Forward voltage bins are defined at  $I_F=150mA$  operation.

Mechanical Dimension

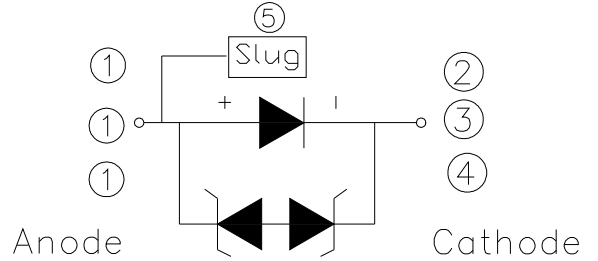
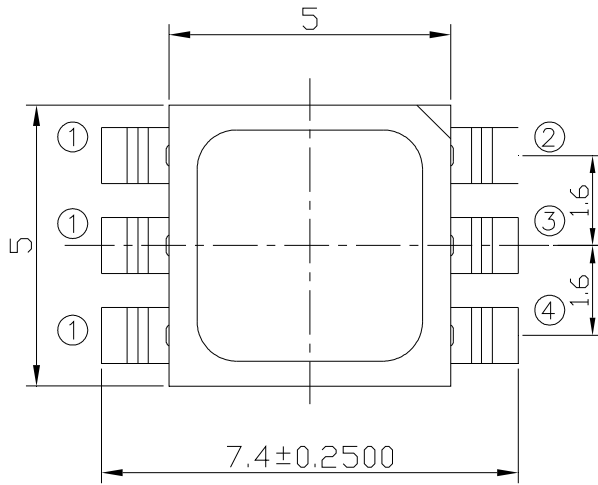

Polarity

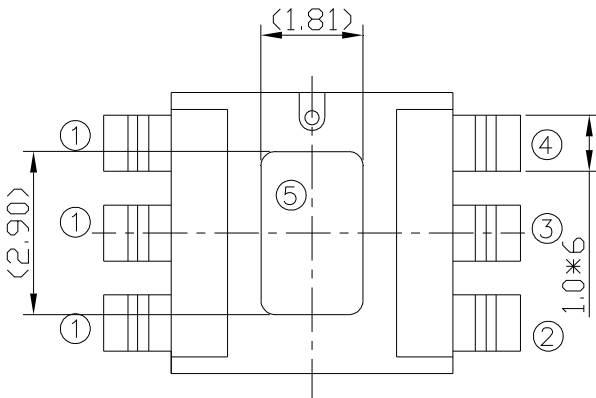
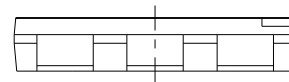
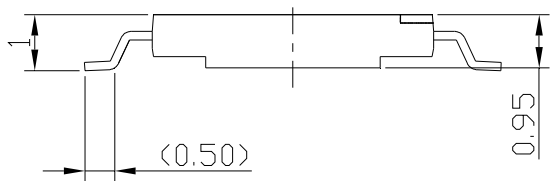

Bot. view

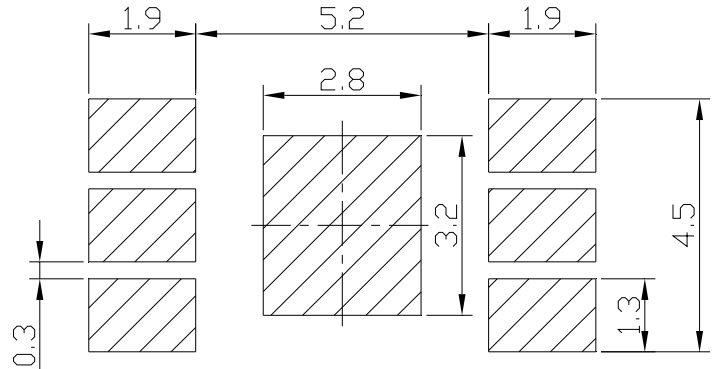

Soldering patterns

Notes.

1. Dimensions are in millimeters.
2. Tolerances for fixed dimensions are  $\pm 0.25\text{mm}$

## Typical Electro-Optical Characteristic Curve

Relative Spectral Distribution  
@ Soldering Temperature = 25

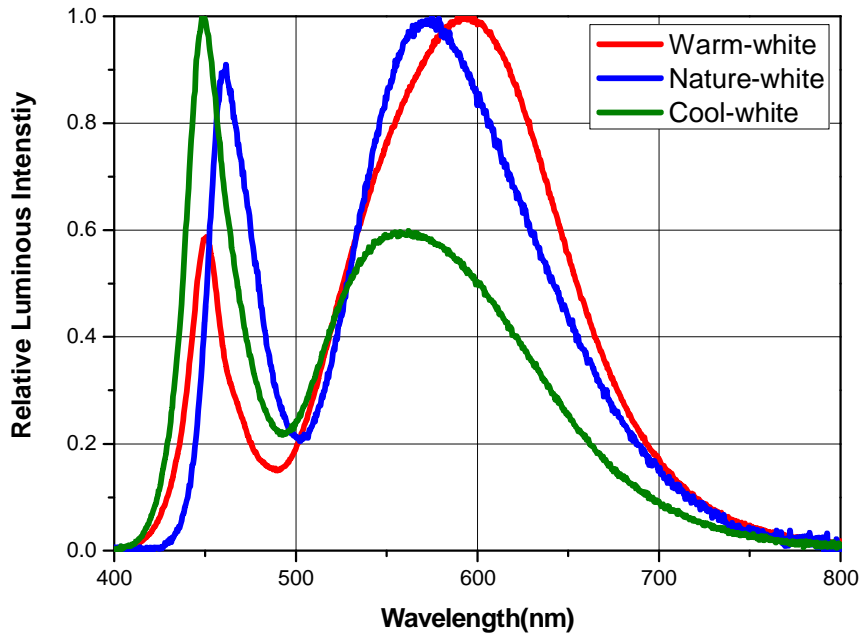

Forward Voltage vs. Forward Current  
@ Soldering Temperature = 25

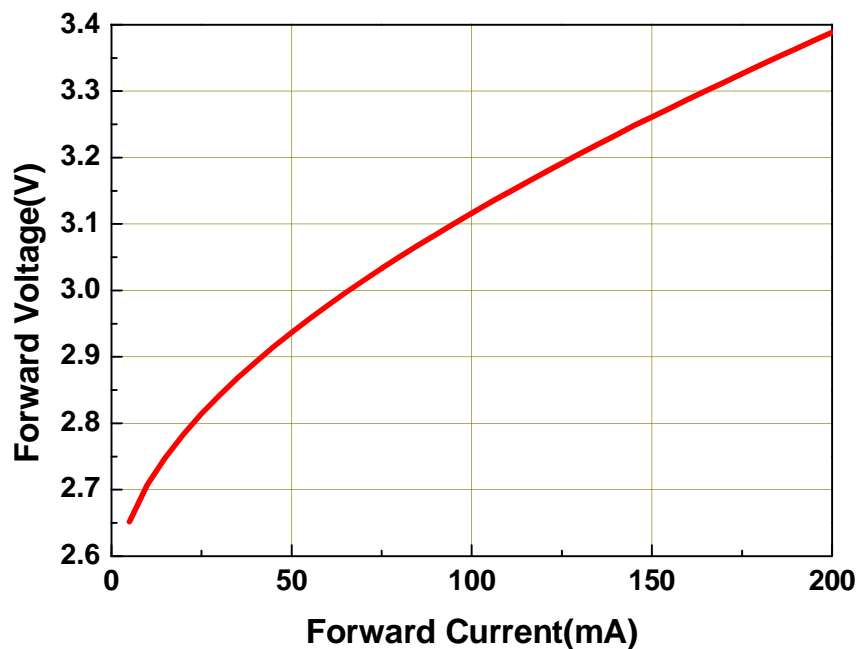

Relative Luminous Flux vs. Forward Current  
@ Soldering Temperature = 25

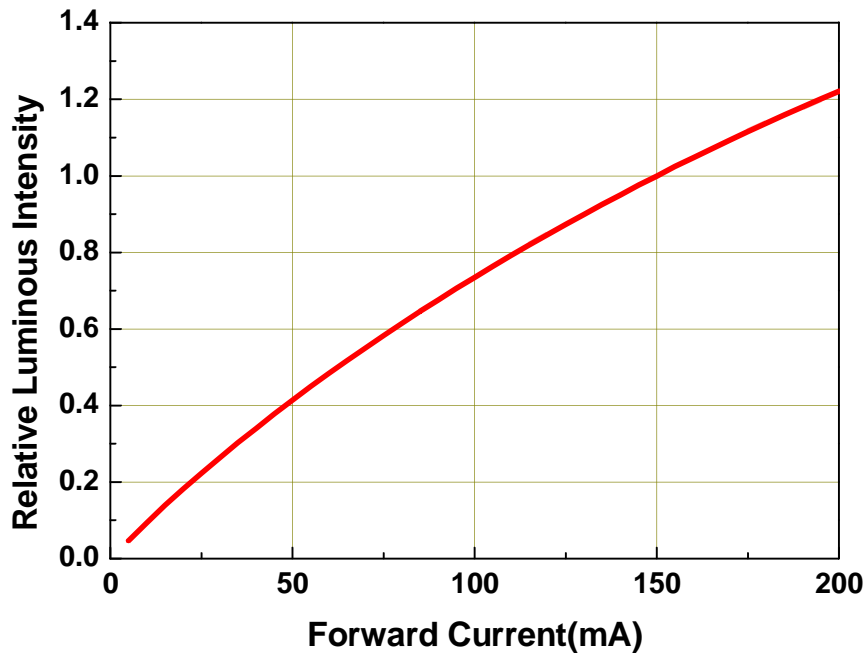

Forward Current Derating Curve  
@ Junction Temperature <125

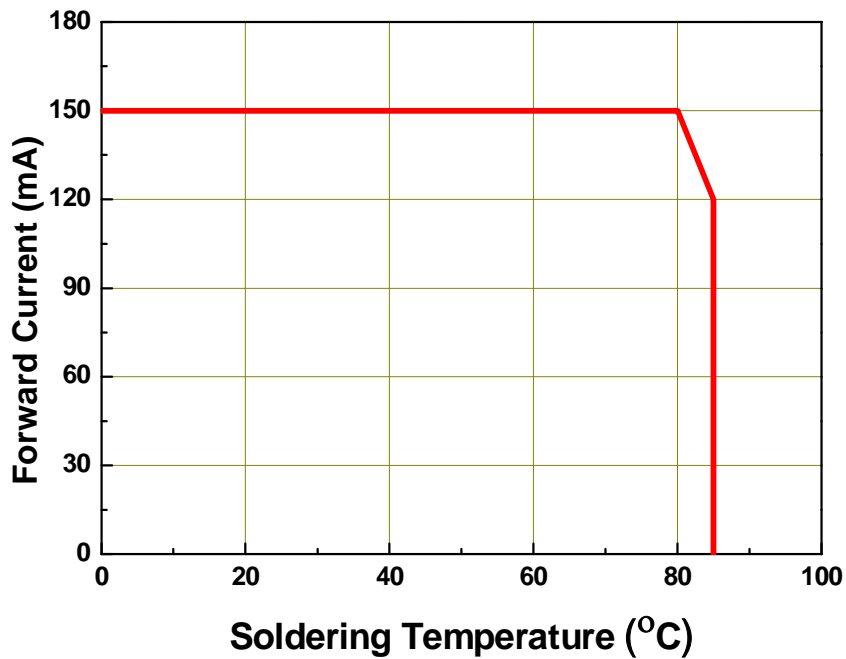



### Typical Diagram Characteristics of Radiation Patterns

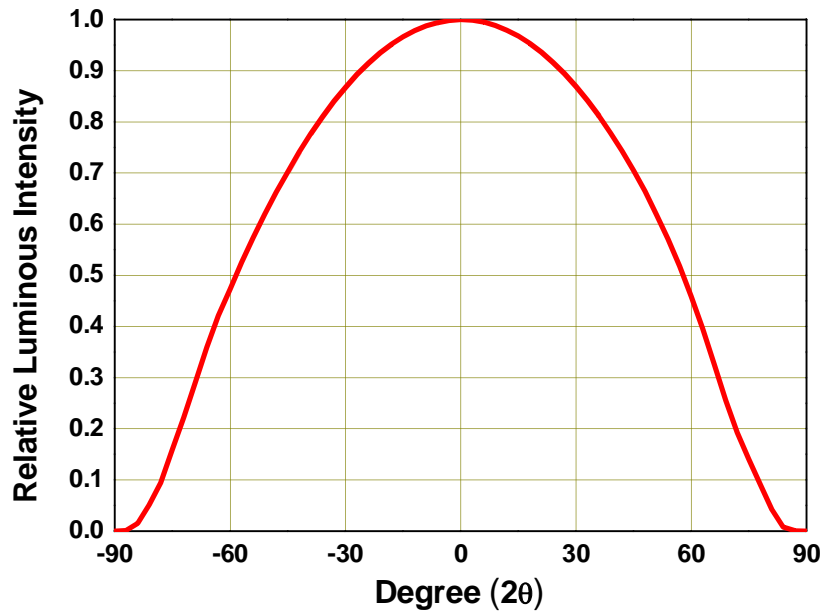

**Note:**

1.  $2\theta_{1/2}$  is the off axis angle from lamp centerline where the luminous intensity is 1/2 of the peak value.
2. Viewing angle tolerance is  $\pm 5^\circ$  .

## Product Labeling

### Label Explanation

CPN: Customer Specification (when required)

P/N : Everlight Production Number

QTY: Packing Quantity

CAT: Luminous Flux (Brightness) Bin

HUE: Color Bin

REF: Forward Voltage Bin

LOT No: Lot Number

MADE IN TAIWAN: Production Place



### Reel Dimensions

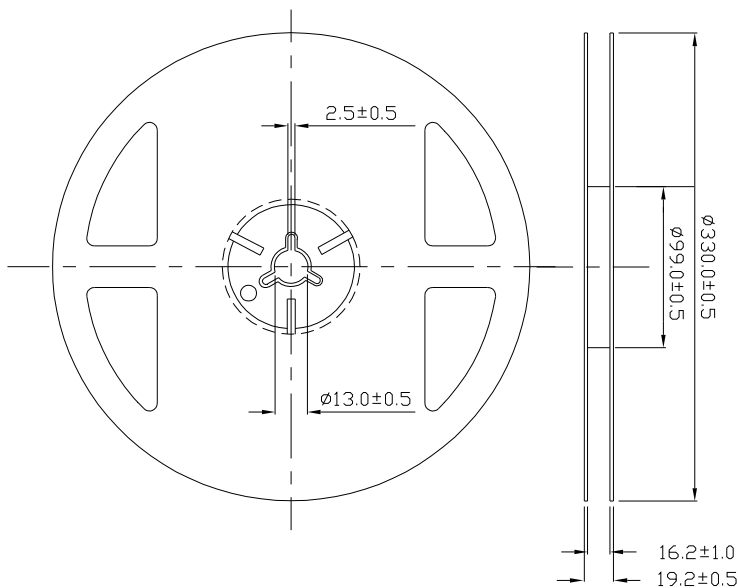

#### Note:

1. Dimensions are in millimeters.
2. Tolerances for fixed dimensions are  $\pm 0.1\text{mm}$ .

## Emitter Tape Packaging

The amount of one reel is 2000pcs, and multiples of 500pcs per reel are acceptable, ex. 500,1000,1500..

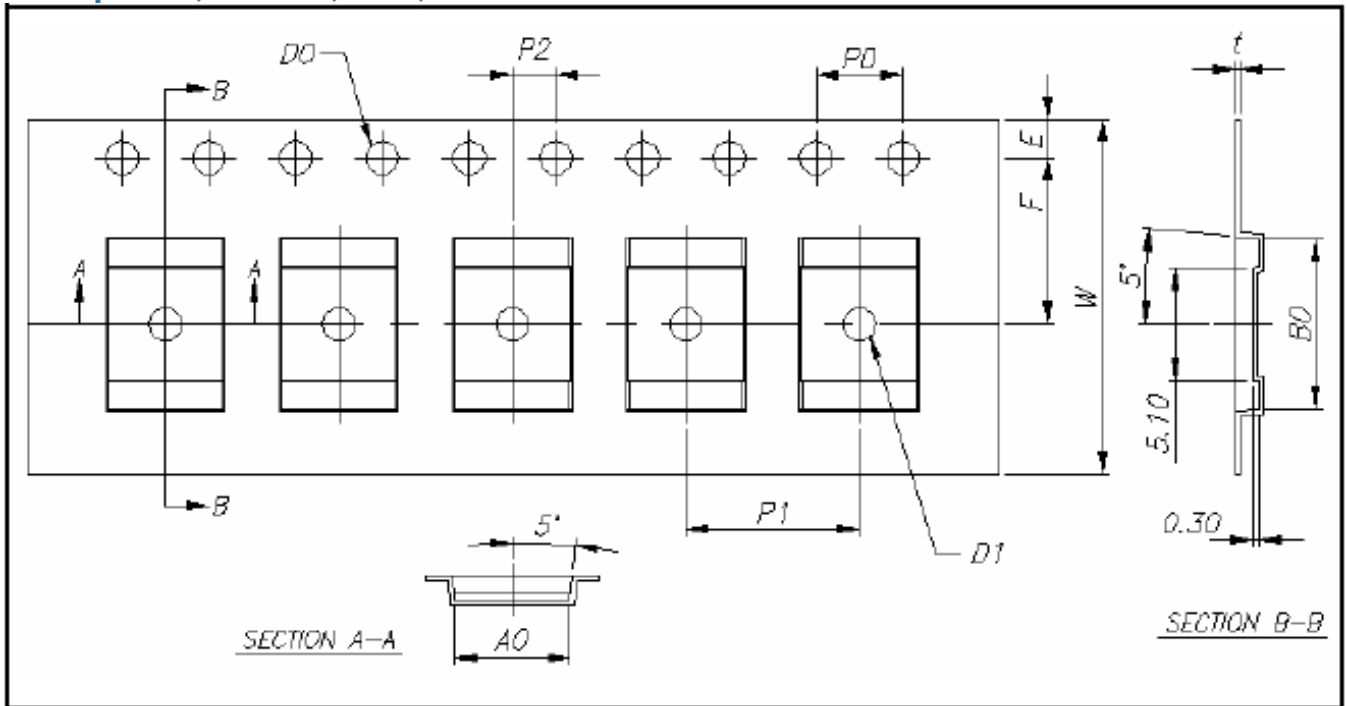

### Note:

1. Dimensions are in millimeters.
2. Tolerances for fixed dimensions are  $\pm 0.1\text{mm}$ .

## Moisture Resistant Packaging

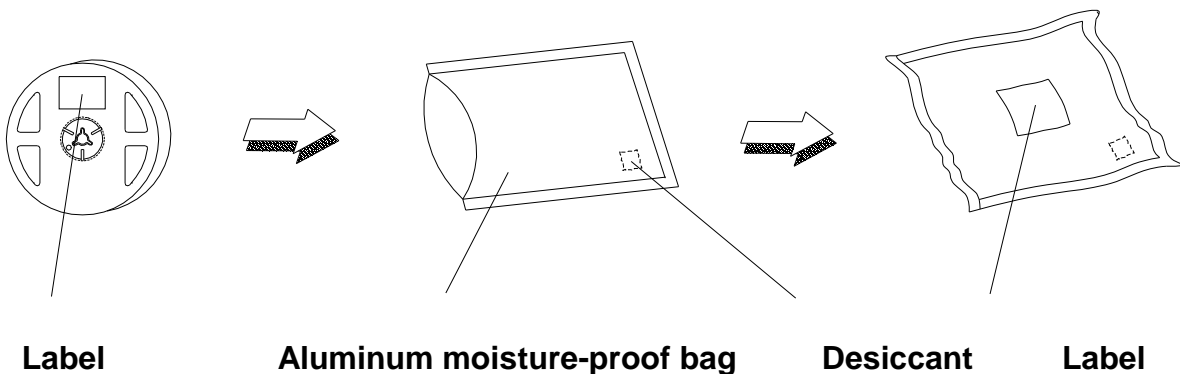

## Precautions of Use

### Over-Current-Proof

- Though the Everlight A22 has a conducted ESD protection mechanism, customers must not use the device in reverse and should apply resistors for extra protection. Otherwise slight voltage shift may cause significant current changes and bum out failure may happen.

### Storage

- Before the package is opened. The LEDs should be stored at 30°C or less and 50%RH or less after being shipped from Everlight and the storage life limits are 6 months. If the LEDs are stored for 6 months or more, they should be stored in a sealed container with a nitrogen atmosphere and moisture absorbent material.
- After opening the package: The LED's should be stored under 30 or less and 30%RH or less. The LED should be used with 168hrs (7days) after opening the package. If unused LEDs remain, it should be stored in moisture proof packages.
- Before using LEDs, baking treatment should be implemented based on the following conditions: pre-curing at 60±5 for 24 hours.
- Do not stack assemblies containing Everlight A22 LEDs so that anything stacks on the optical surface of LEDs. Forces applied to the optical surface may result in the surface being damaged.

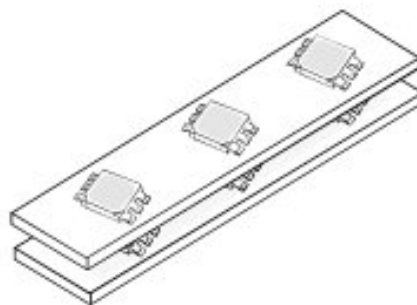

## Handling

- Don not putting mechanical stress on the LED.
- Never touch the optical surface with finger or sharp object. The LED surface could be soiled or damaged, which could affect the optical performance of the LED.
- Avoid directly contacting the lens with downward force of more than 300g

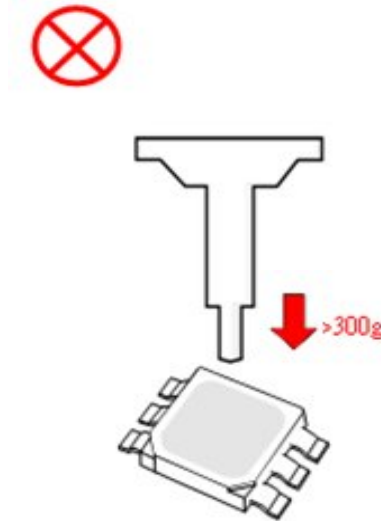

- Sealing process with water proof silicone is not suitable for EHP-A22 products

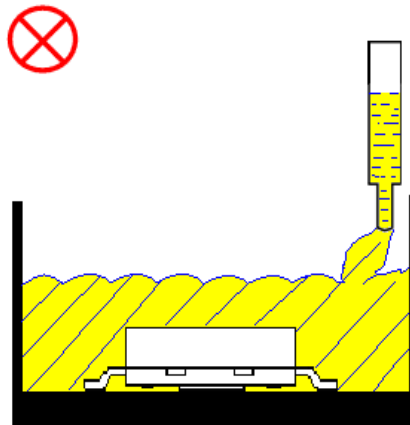

- In low-humidity work environment, please keep handling the LEDs with appropriate ESD grounding.
- It is recommended to handle the LED with powder-less latex gloves.

## Manual Handling

- When handling the product, do not apply direct pressure on the optical surface.

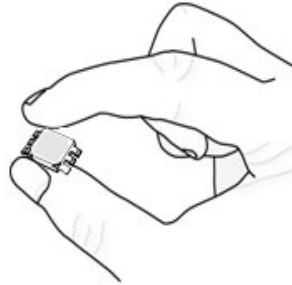

- Do not touch the resin with tweezers to avoid scratching or other damage.



## Thermal Management

- For maintaining the high flux output and achieving maximum reliability, EHP-A22 series LEDs should be mounted on a metal core printed circuit board (MCPCB) or other kinds of heat sink with proper thermal connection to dissipate approximately 0.5W of thermal energy at 150mA operation.
- Heat dissipation or thermal conduction design is strongly recommended on PCB or MCPCB for reflow soldering purposes. Please refer to soldering patterns on Page 14.
- Sufficient thermal management must be implemented. Please refer to the graph “Forward Current Derating Curve “ on Page 16 The soldering temperature must be kept under 80 at the driving current 150mA. Otherwise, the junction temperature of die may exceed over the limit at high current driving conditions and the LEDs’ lifetime may be decrease dramatically.
- Sufficient thermal management must be conducted, or the die junction temperature will be over the limit under large electronic driving and LED lifetime will decrease critically.

## Soldering Ion for Reflow Process

- EHP-A22 series are suitable for SMT process.
- Curing of glue in oven according to standard operation flow processes.

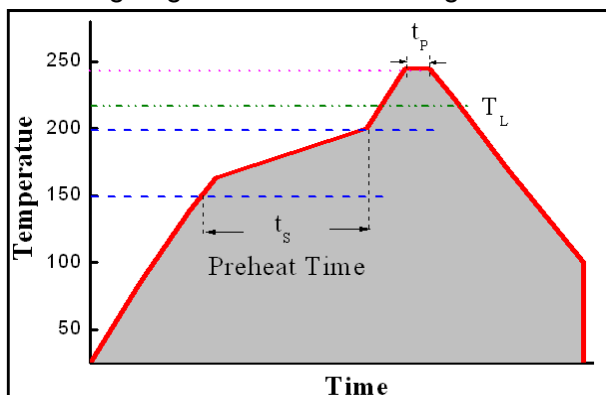

Profile Feature	Lead Free Assembly
Ramp-Up Rate	2-3 °C/S
Preheat Temperature	150-200 °C
Preheat Time (t <sub>s</sub> )	60-120 S
Liquid Temperature (T <sub>L</sub> )	217 °C
Time maintained above T <sub>L</sub>	60-90 S
Peak Temperature (T <sub>p</sub> )	240±5 °C
Peak Time (t <sub>p</sub> )	Max 20 S
Ramp-Down Rate	3-5 °C/S

- Reflow soldering should not be done more than twice.
- In soldering process, stress on the LEDs during heating should be avoided.
- After soldering, do not warp the circuit board.

## Soldering Ion for Manual Soldering Process

- For prototype builds or small series production runs it is possible to place and solder the LED by hand.
- Dispense thermal conductive glue or grease on the substrates and follow its curing specifications. Gently press LED housing to closely connect LED and substrate.
- It is recommended to hand solder the leads with a solder tip temperature of 280°C for less than 3 second, at a time with a soldering iron of less than 25W. Solder at intervals of two seconds or more.
- Take caution and be aware that damaged products are often a result of improper hand soldering technique.

## Revision History

Current version: 04.15.2013

Issue No: DHE-0001807

Version: 3

Page	Subjects (major change in previous version)	Date of change
P11	Change the LED picture	12.17.2012
P19	Change the Loaded Quantity	04.15.2013